

- 89%
- 0.95
- 
- IP66
- 
- Class 2 SELV



EUV-042SxxxPS

90 ~ 305 Vac

12 Vdc	90 ~ 305 Vac	0~3500 mA	42 W	84%	0.96	0.95	EUV-042S012PS <sup>(3)</sup>
24 Vdc	90 ~ 305 Vac	0~1750 mA	42 W	86%	0.96	0.95	EUV-042S024PS <sup>(3)</sup>
36 Vdc	90 ~ 305 Vac	0~1160 mA	42 W	87%	0.96	0.95	EUV-042S036PS <sup>(3)</sup>
48 Vdc	90 ~ 305 Vac	0~875 mA	42 W	89%	0.96	0.95	EUV-042S048PS <sup>(4)</sup>

- 1 UL, FCC : 100-277Vac; UL & FCC : 100~ 240Vac
- 2 220Vac, 100%
- 3 Class 2 &
- 4 Class 2 , Class 2

	90 Vac	-	305 Vac	
	47 Hz	-	63 Hz	
	-	-	0.75 mA	277Vac/60Hz
	-	-	0.70 mA	IEC60598-1; 240Vac/ 60Hz
	-	-	0.6 A	100Vac, 100%
	-	-	0.3 A	220Vac, 100%
	-	-	70 A	220Vac 25 10% -
I <sup>2</sup> t	-	-	0.16 A <sup>2</sup> s	10% = 100 μs



	327,000 hours	-	-	120Vac 25,80% (MIL-HDBK-217F)
	-	116,000 Hours	-	120Vac 80% 60
	-40	-	+90	
	-40		+70	: 10% RH to 100% RH
	-40		+85	: 5% RH to 100% RH
(L x W x H) (L x W x H)	3.74 x 2.76 x 1.26 95 x 70 x 32			
	-	390 g	-	

25°C

UL/CUL	UL8750, UL 1310, CAN/CSA-C22.2 No. 250.13, CAN/CSA-C22.2 No. 223-M91
CE	EN 61347-1, EN61347-2-13
KS	KS C 7655
EN 55015 <sup>(1)</sup>	Conducted Emission Test & Radiated Emission Test
EN 61000-3-2	Harmonic current emissions
EN 61000-3-3	Voltage fluctuations & flicker
FCC Part 15 <sup>(1)</sup>	ANSI C63.4 Class B This device complies with Part 15 of the FCC Rules. Operation is subject to the following two conditions: [1] this device may not cause harmful interference, and [2] this device must accept any interference received, including interference that may cause undesired operation.
<b>EMS</b>	
EN 61000-4-2	Electrostatic Discharge (ESD): 8 kV air discharge, 4 kV contact discharge
EN 61000-4-3	Radio-Frequency Electromagnetic Field Susceptibility Test-RS

EMS	
EN 61000-4-4	Electrical Fast Transient / Burst-EFT
EN 61000-4-5	Surge Immunity Test: AC Power Line: Differential Mode 2 kV
EN 61000-4-6	Conducted Radio Frequency Disturbances Test-CS
EN 61000-4-8	Power Frequency Magnetic Field Test
EN 61000-4-11	Voltage Dips
EN 61547	Electromagnetic Immunity Requirements Applies To Lighting Equipment

1 EMI

( ) EMI

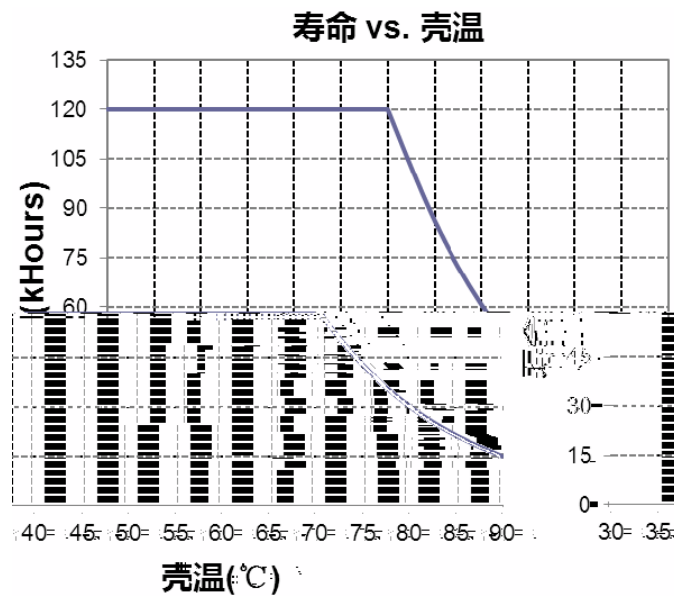

**EUV-042S012PS**  
效率 vs. 输出电流

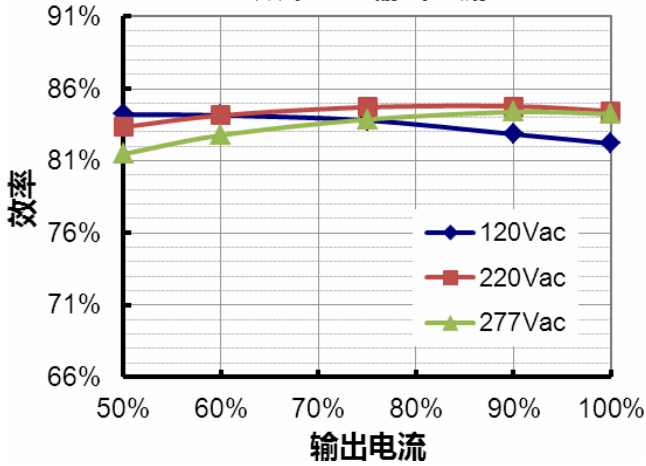

**EUV-042S024PS**  
效率 vs. 输出电流

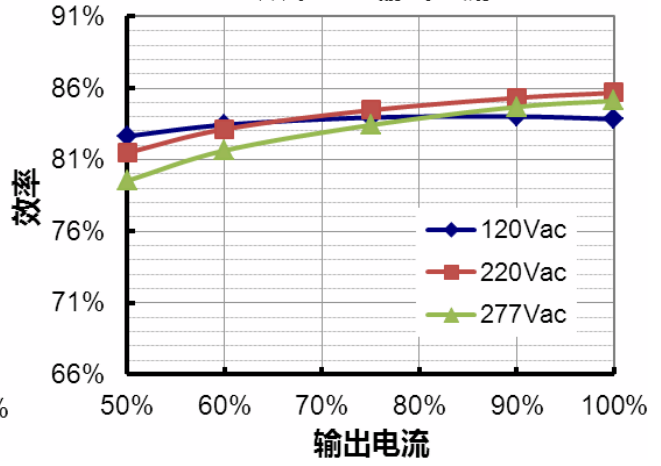

**EUV-042S036PS**  
效率 vs. 输出电流

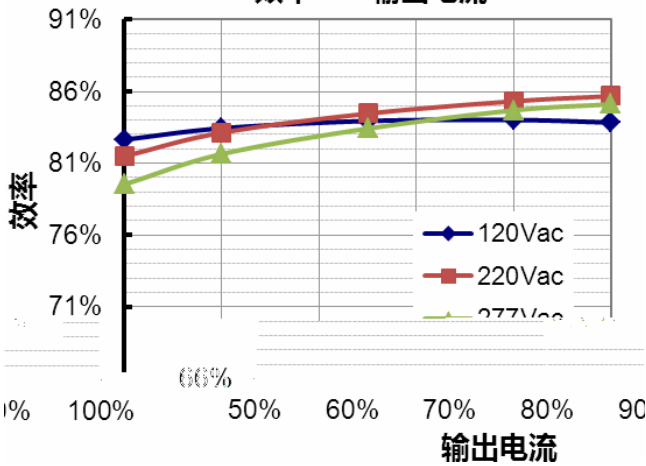

**EUV-042S048PS**  
效率 vs. 输出电流

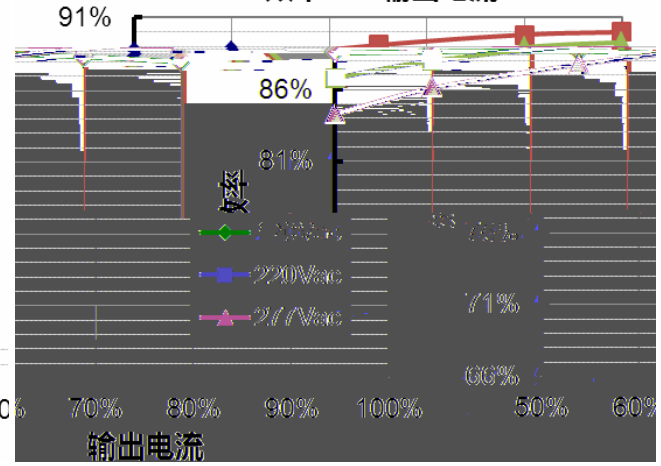

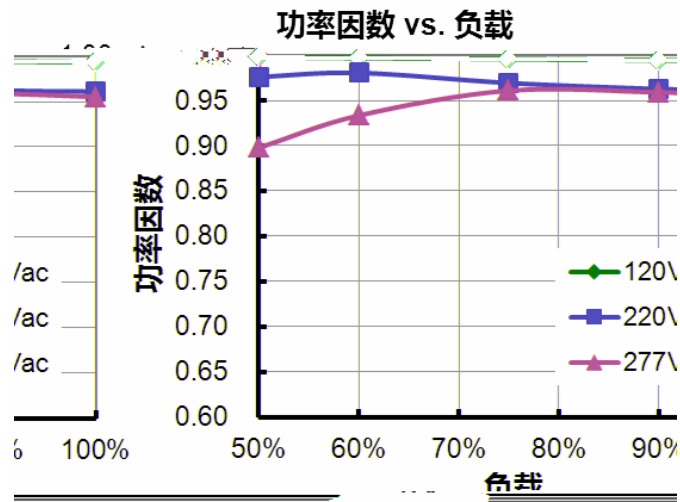

	1.1 lo	1.4 lo	1.7 lo	
-Tc	110		75	

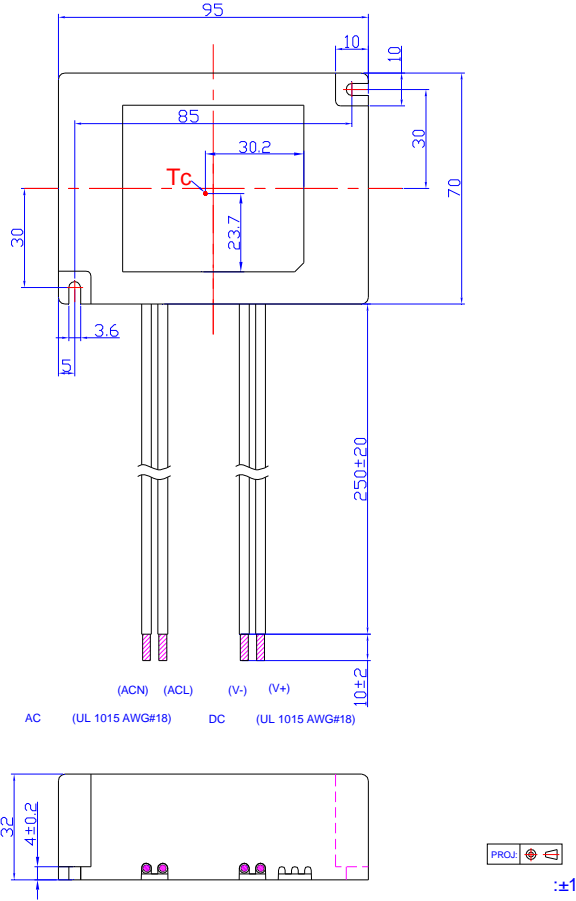

RoHS 2011/65/EU

EU 2015/863

